

## PE-Einschweiss-Schieber, PN 16

4810

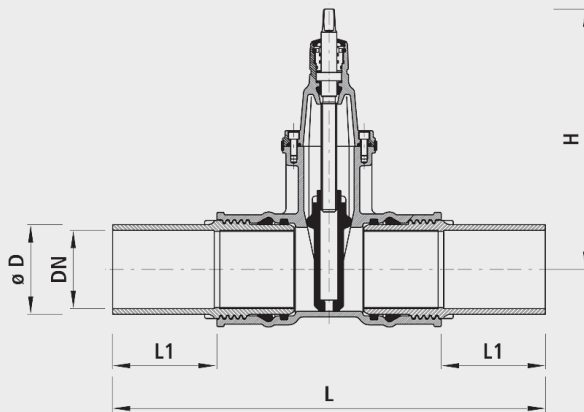

## Anwendung



















- Die PE-Anschweiss-Armaturen können mit Elektroschweissmuffen, Heizelement-Stumpfschweissungen oder mechanischen Klemmverbindungen kraftschlüssig verbunden werden.
- Die Stutzen sind mit doppelter Abdichtung (Lippendichtung, O-Ring-Dichtung) und Stützhülse kraftschlüssig in den Armaturenkörper eingeschraubt.
- Die PE-Anschweissenden können bei Schiebern einzeln ausgewechselt werden.
- Geeignet für alle PE-Rohre. Die Verarbeitung richtet sich nach den Richtlinien des VKR (Verband der Kunststoff-Rohre und Rohrleitungsteile, Aarau).
- Die PE-Stutzen können bei Bedarf oder Umbau ausgewechselt werden. Armaturen sind dadurch bei einem defekten PE-Stutzen wieder verwendbar.

## Eigenschaften

- Betriebstemperatur - max. 40 °C
- Druckstufe PN 16

## Werkstoff

- Ausgedreht auf SDR 17, auf Anfrage (Nr. 4811)
- Gehäuse
  - Sphäroguss EN-GJS-400 (GGG 40)
  - EWS-Beschichtung nach GSK, RAL-GZ 662, Schichtdicke min. 250 µm
- Dichtungen
  - O-Ring: EPDM
  - Muffendichtung: EPDM
- Einschweisstutzen
  - Standard: PE 100, SDR 11
  - Auf Anfrage: auf SDR 17 ausgedreht
- Stützhülse
  - INOX

		DN	ø D	PN (bar)	H (mm)	L (mm)	L1 (mm)	Bohrung s-ø max. (mm)	Gewicht (kg)	NPK-Nr. 411	NPK-Nr. 412	BIM / CAD
4810032032	x	1"	32	16	160	505	160	20	3.200	814112	813211	
4810040040	x	1 1/4"	40	16	190	535	160	27	5.000	814113	813212	
4810050050	x	1 1/2"	50	16	195	570	165	32	5.700	814114	813213	
4810050063		50	63	16	234	650	185	41	11.500	814115	813214	
4810065075		65	75	16	305	660	180	53	17.000	814116	813215	
4810080090		80	90	16	313	670	180	64	19.000	814117	813216	
4810100110		100	110	16	343	710	185	79	26.000	814118	813217	
4810100125		100	125	16	343	755	180	93	30.500	814119	813218	
4810125140		125	140	16	421	780	180	105	31.500	814121	813221	
4810125160	o	125	160	16	421	860	220	118	52.200	814122	813222	
4810150160		150	160	16	433	790	180	119	50.500	814122	813222	
4810150180		150	180	16	433	810	175	135	57.500	814123	813223	
4810150200	o	150	200	16	433	1170	370	135	57.000	814124	813224	
4810200200		200	200	16	541	900	190	161	88.000	814124	813224	
4810200225		200	225	16	541	900	190	170	90.000	814125	813225	
4810200250	o	200	250	16	541	1040	280		92.000	814126	813226	
4810250280	o	250	280	16	649	1100	260		137.000	814127	813227	
4810250315	o	250	315	16	649	1560	480		151.000	814128	813228	
4810300315	o	300	315	16	731	1240	280		207.000	814128	813228	
4810300355	o	300	355	16	731	1240	280		211.000			

x = Hausanschluss-Einbaugarnituren verwenden.

o = Kombination aus BAIO®-Schieber (Nr. 4500) und PE-Anschweissenden (Nr. 4520)