

## Valvola a farfalla con leva a mano, tipo LT, PN 16

9942

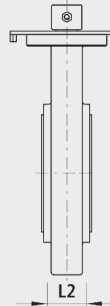
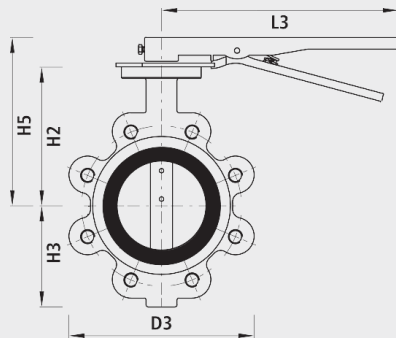

## Applicazione

- Per acqua fino a max. 40 °C
- Corpo monoblocco per l'installazione sulle flange in conformità alle norme DIN 2501, PN 10 o PN 16.

## Caratteristiche







- Il disco della farfalla è posizionato centralmente in modo da ottimizzare il flusso e chiude ermeticamente in entrambi i sensi del flusso.
- Quote di accoppiamento-flangia
  - secondo DIN EN 1092-2
  - DN 40 a DN 150: PN 10 / 16
  - DN 200 a DN 400: PN 10 oppure PN 16, indicare nell'ordine
  - DN 65: Flangia a 4 fori

## Materiale

- Corpo: EN-JS 1030 (GGG 40)
- Rosetta: INOX 1.4408
- Albero: INOX 1.4005, con molla ad anello
- Sede: EPDM
- Rivestimento in EWS secondo GSK, RAL-GZ 662, interno ed esterno a norma DIN 30677

## Montaggio e installazione

- Non utilizzare guarnizioni supplementari.
- La valvola può essere utilizzata come rubinetteria terminale.
- Il collegamento diretto con la flangia bordata non funziona

	DN	PN (bar)	L2 (mm)	L3 (mm)	D3 (mm)	H2 (mm)	H3 (mm)	H5 (mm)	Peso (kg)	N° CPN 411	BIM / CAD
9942040000	40	16	36	267	115	130	65	164	3.700	831235	
9942050000	50	16	46	267	118	124	78	157	4.900	831236	
9942065000	65	16	49	267	164	134	88	167	6.600	831237	
9942080000	80	16	49	267	183	141	98	174	7.400	831238	
9942100000	100	16	56	267	206	156	110	189	7.500	831239	
9942125000	125	16	59	267	240	170	128	203	11.500	831241	
9942150000	150	16	59	267	268	186	143	219	12.500	831242	
9942200000	200	10	65	353	335	218	180	258	24.400	831243	
9942201000	200	16	65	353	335	218	180	258	24.400	831243	
9942250000	250	10	73	353	398	249	205	289	29.700	831244	