

Vanne papillon avec réducteur, type LT, PN 16

9943

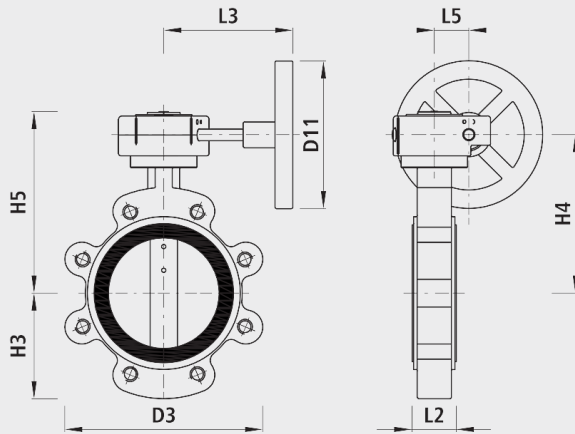

Application

- Pour eau jusqu'à max. 40 °C
- Corps monobloc pour l'installation sur les brides selon DIN 2501, PN 10 ou PN 16.

Caractéristiques

- Le disque de clapet est à axe centré et de forme hydrodynamique, et ferme étanche dans les deux sens d'écoulement.
- Cotes de raccordement pour brides
 - selon DIN EN 1092-2
 - DN 40 à DN 150: PN 10 / 16
 - DN 200 à DN 400: PN 10 ou PN 16, indiquer à la commande
 - DN 65: bride à 4 trous

Matière













- Corps: EN-JS 1030 (GGG 40)
- Disque: INOX 1.4408
- Arbre: INOX 1.4005, avec rondelle ressort
- Siège: EPDM
- Revêtement EWS selon GSK, RAL-GZ 662, intérieur et extérieur selon DIN 30677

Installation et montage

- Ne pas utiliser de joints supplémentaires.
- Le clapet peut être utilisé comme robinetterie de sortie.
- Le raccord direct avec bride évasée ne fonctionne pas

Attention

- Dimensions plus grands sur demande

	DN	PN (bar)	L2 (mm)	L3 (mm)	L5	D3 (mm)	D11	H3 (mm)	H4 (mm)	H5 (mm)	Poids (kg)	N° CAN 411	BIM / CAD
9943040000	40	16	36	128	44	115	125	65	156	181	3.900	831215	
9943050000	50	16	46	128	44	118	125	78	150	175	5.800	831216	
9943065000	65	16	49	128	44	164	125	88	160	185	7.400	831217	
9943080000	80	16	49	128	44	183	125	98	167	192	8.400	831218	
9943100000	100	16	56	137	53	206	125	110	186	219	8.600	831219	
9943125000	125	16	59	137	53	240	125	128	200	233	12.400	831221	
9943150000	150	16	59	153	53	268	200	143	216	249	15.100	831222	
9943200000	200	10	65	153	53	335	200	180	248	281	27.700	831223	
9943201000	200	16	65	153	53	335	200	180	248	281	27.700	831223	
9943250000	250	10	73	192	62	398	200	205	284	326	33.500	831224	
9943251000	250	16	73	192	62	398	200	205	284	326	33.500	831224	
9943300000	300	10	83	218	62	465	250	250	320	362	59.000	831225	
9943301000	300	16	83	218	62	465	250	250	320	362	59.000	831225	