

Flange-T-piece, PN 16

8510

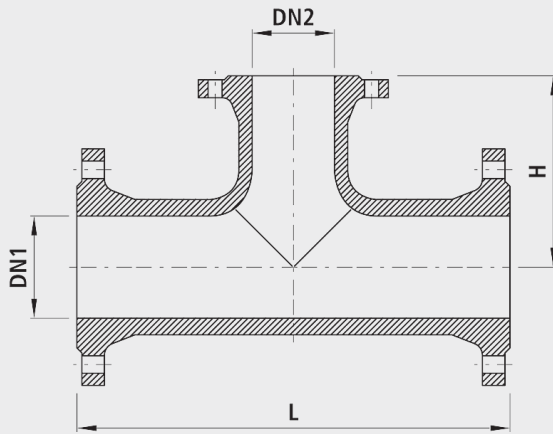



































Material

- Housing
 - Spheroidal graphite cast iron EN-GJS-400 (GGG 40)
 - EWS coating according to GSK, RAL-GZ 662, coating thickness min. 250 µm

Caution

- Special lengths up to 2000 mm as well as special shapes according to sketches are available on request in powder/coated steel 37

	DN1 (mm)	DN2 (mm)	PN (bar)	L (mm)	H (mm)	weight (kg)	NPK No. 411	NPK No. 412	BIM / CAD
8510050050	50	50	16	300	150	11.200	247116		
8510065050	65	50	16	330	155	15.500	247157		
8510065065	65	65	16	330	165	15.100	247117		
8510080050	80	50	16	330	160	15.400	247158	243131	
8510080065	80	65	16	330	165	14.700	247178		
8510080080	80	80	16	330	165	15.600	247118	243111	
8510100050	100	50	16	360	170	16.600	247159	243132	
8510100065	100	65	16	360	170	18.000	247179		
8510100080	100	80	16	360	175	17.600	247219	243142	
8510100100	100	100	16	360	180	19.000	247119	243112	
8510125050	125	50	16	400	185	21.500	247161	243133	
8510125065	125	65	16	400	185	31.000	247181		
8510125080	125	80	16	400	190	23.000	247221	243143	
8510125100	125	100	16	400	195	24.500	247241	243153	
8510125125	125	125	16	400	200	26.000	247121	243113	
8510150050	150	50	16	440	200	27.500	247162	243134	
8510150065	150	65	16	440	200	19.800	247182		
8510150080	150	80	16	440	205	28.800	247222	243144	
8510150100	150	100	16	440	210	29.500	247242	243154	
8510150125	150	125	16	440	215	31.000	247262	243164	
8510150150	150	150	16	440	220	34.400	247122	243114	

8510200050	200	50	10	520	230	42.500	243163	243225	
8510200080	200	80	10	520	235	43.000	243223	243235	
8510200100	200	100	10	520	240	45.300	243243	243245	
8510200125	200	125	10	520	245	47.600	243263	243255	
8510200150	200	150	10	520	250	47.500	243283	243265	
8510200200	200	200	10	520	260	53.000	243123	243315	
8510201050	200	50	16	520	230	42.200	247163	243425	
8510201080	200	80	16	520	235	44.000	247223	243435	
8510201100	200	100	16	520	240	46.500	247243	243445	
8510201125	200	125	16	520	245	47.200	247263	243455	
8510201150	200	150	16	520	250	46.500	247283	243465	
8510201201	200	200	16	520	260	50.000	247123	243515	
8510250080	250	80	10	700	270	71.000	243224	243236	
8510250100	250	100	10	700	275	75.000	243244	243246	
8510250125	250	125	10	700	285	68.000	243264	243256	
8510250150	250	150	10	700	300	81.000	243284	243266	
8510250200	250	200	10	700	325	76.500	243324	243336	
8510250250	250	250	10	700	350	83.000	243124	243316	
8510251080	250	80	16	700	270	71.000	247224	243436	
8510251100	250	100	16	700	275	75.000	247244	243446	
8510251125	250	125	16	700	285	62.200	247264	243456	
8510251150	250	150	16	700	300	73.000	247284	243466	
8510251200	250	200	16	700	325	76.500	247324	243536	
8510251251	250	250	16	700	350	84.400	247124	243516	
8510300080	300	80	10	800	290	92.000	243225	243237	
8510300100	300	100	10	800	300	94.000	243245	243247	
8510300150	300	150	10	800	325	101.000	243285	243267	
8510300200	300	200	10	800	350	102.000	243325	243337	
8510300250	300	250	10	800	375	112.000	243345	243347	
8510300300	300	300	10	800	400	100.000	243125	243317	
8510301080	300	80	16	800	290	92.000	247225	243437	
8510301100	300	100	16	800	300	94.000	247245	243447	
8510301150	300	150	16	800	325	101.000	247285	243467	
8510301200	300	200	16	800	350	102.000	247325	243537	
8510301250	300	250	16	800	375	112.000	247345	243547	
8510301301	300	300	16	800	400	114.000	247125	243517	