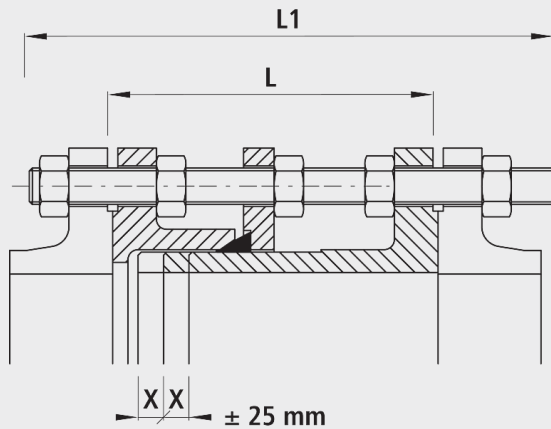

Ein-/Ausbaustück, PN10/16

7160

**Application**

- To compensate for any discrepancies in length

Characteristics



















- Housing made of cast steel powder coated epoxy (colour RAL 5015)
- The threaded anchors including nuts are available as standard in galvanised or V2A (threaded anchor) and V4A special coated (nut)
- The pull protection is ensured by the threaded anchors with nuts

Material

- Rubber seal: EPDM (Nr. 7160900...)

Caution

- The compensation for the length of the chock/dismantling joint is always taken as +/- 25mm from the L dimension.

	DN	PN (bar)	V2A/V4A	L (mm)	L1	X + / -	weight (kg)	NPK No. 411	BIM / CAD
716000050	50	16		180	310	25	11.000	841116	
716010050	50	16	x	180	310	25	11.000	841116	
716000065	65	16		180	310	25	13.000	841117	
716010065	65	16	x	180	310	25	13.000	841117	
716000080	80	16		200	330	25	18.000	841118	
716010080	80	16	x	200	330	25	17.000	841118	
716000100	100	16		200	330	25	21.000	841119	
7160100100	100	16	x	200	330	25	21.000	841119	
7160000125	125	16		200	330	25	26.000	841141	
7160100125	125	16	x	200	330	25	26.000	841141	
7160000150	150	16		200	330	25	35.000	841142	
7160100150	150	16	x	200	330	25	35.000	841142	
7160000200	200	10		220	330	25	49.000	841123	
7160100200	200	10	x	220	330	25	49.000	841123	
7160000201	200	16		220	330	25	52.000	841143	
7160100201	200	16	x	220	330	25	52.000	841143	
7160000250	250	10		220	360	25	64.000	841124	
7160100250	250	10	x	220	360	25	64.000	841124	
7160000251	250	16		230	370	25	76.000	841144	
7160100251	250	16	x	230	370	25	76.000	841144	
7160000300	300	10		220	360	25	73.000	841125	
7160100300	300	10	x	220	360	25	73.000	841125	
7160000301	300	16		250	410	25	93.000	841145	
7160100301	300	16	x	250	410	25	93.000	841145	
7160000350	350	10		230	360	25	96.000	841126	
7160100350	350	10	x	230	360	25	96.000	841126	
7160000351	350	16		260	410	25	129.000	841146	
7160100351	350	16	x	260	410	25	129.000	841146	
7160000400	400	10		230	370	25	124.000	841127	
7160100400	400	10	x	230	370	25	124.000	841127	
7160000401	400	16		270	430	25	164.000	841147	
7160100401	400	16	x	270	430	25	164.000	841147	
7160000450	450	10		250	390	25	141.000		
7160100450	450	10	x	250	390	25	141.000		
7160000451	450	16		270	430	25	190.000		
7160100451	450	16	x	270	430	25	190.000		
7160000500	500	10		260	390	25	160.000		
7160100500	500	10	x	260	390	25	160.000		
7160000501	500	16		280	440	25	243.000		
7160100501	500	16	x	280	440	25	243.000		
7160000600	600	10		260	410	25	207.000		
7160100600	600	10	x	260	410	25	207.000		
7160000601	600	16		300	500	25	332.000		
7160100601	600	16	x	300	500	25	332.000		

716000700	700	10		260	410	25	259.000	
7160100700	700	10	x	260	410	25	259.000	
716000701	700	16		300	500	25	368.000	
7160100701	700	16	x	300	500	25	368.000	
716000800	800	10		290	460	25	354.000	
7160100800	800	10	x	290	460	25	354.000	
716000801	800	16		320	520	25	480.000	
7160100801	800	16	x	320	520	25	480.000	
716000900	900	10		290	460	25	415.000	
7160100900	900	10	x	290	460	25	415.000	
716000901	900	16		320	520	25	548.000	
7160100901	900	16	x	320	520	25	548.000	
7160001000	1000	10		290	500	25	560.000	
7160101000	1000	10	x	290	500	25	560.000	
7160001001	1000	16		340	560	25	719.000	
7160101001	1000	16	x	340	560	25	719.000	