

# Pressure reducing valve

1500

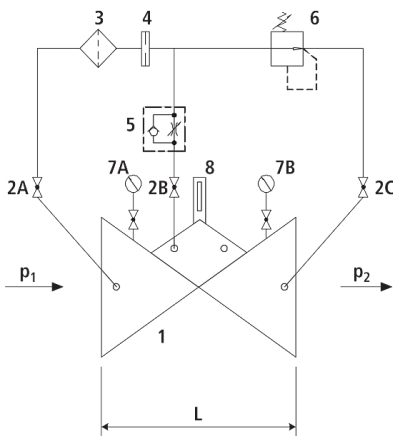
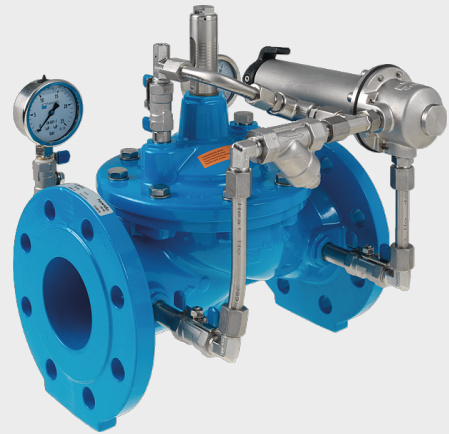
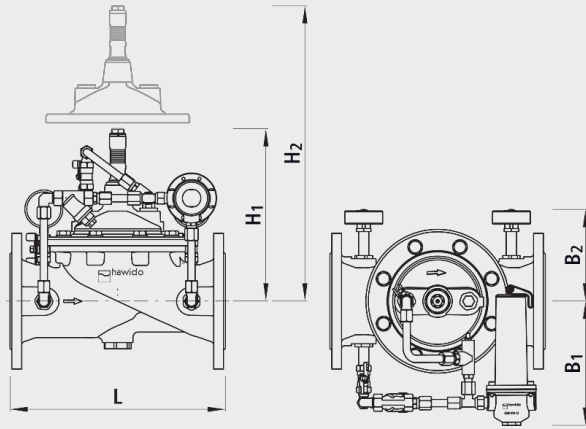

## Components

- 1: Main valve
- 2: Ball valve (A, B, C)
- 3: Filter
- 4: Orifice
- 5: Throttle check valve
- 6: Control valve
- 7: Manometer with ball valve (A, B)
- 8: Optical position indicator (optional: Electrical position indicator, opening limiter)

## Physical characteristics

- The main valve is a hydraulically operating diaphragm valve. The work energy is the inherent medium.
- Most valve types operate purely hydraulically without any foreign energy.

## Application

- To use in drinking water systems (other media after consultation)
- Reduction in pressure to supply the network
- Emergency feed into a second network (network connections)

## Mode of operation

- The pressure reducing valve reduces a variable inlet pressure to a constant outlet pressure. Fluctuating inlet pressure and flow rate have no effect on the outlet pressure controlled by the control valve. The outlet pressure is adjustable in the range from 1.5 to 12 bar (standard design).

## Product information

- To calculate the dimensions of the valve please refer to the following information:
- Maximum and minimum inlet pressure (static and dynamic pressure ratios)
- Desired outlet pressure
- Maximum and minimum flow rates
- Possible requirement for extinguishing water
- Available line diameters and lengths
- Construction of the valve (straight or angle design)
- For the calculation basis, information on the loss of pressure and the characteristic values of the valve, please refer to the end of Chapter E.

## Design

- Design according to DIN EN 1074
- Construction length acc. to DIN EN 558
- Flange mass according to DIN 1092-2, to PN 25 DN 300
- Pressure levels: PN 10 or PN 16 to DN 300, PN 25 to DN 200, higher pressures on request.
- Nominal widths DN 50, DN 80, DN 100 and DN 150 available in angular design
- Nominal widths 1 1/2" and 2" with threaded connection (female thread)
- Medium temperature up to 40°C

## Installation and assembly



















- Shut-off valves should be fitted on both sides of the valve and a dirt trap should be installed on the inlet side of the valve. Depending on the installation situation, a mounting/dismounting adapter and an aeration and ventilation system should be provided.

## Vantages

- Maintenance-free, non-rusting valve seat
- Pressed-in seat
- EWS-coating according to RAL GSK

## Caution

- Dimension H1 with electric position indicator and opening limiter is 110 mm higher up to DN 100 and 130 mm higher at DN 125 to DN 300.

	DN	PN (bar)	L (mm)	B1 (mm)	B2 (mm)	H1 (mm)	H2 (mm)	KVS l/min.	weight (kg)	NPK No. 411	BIM / CAD
150007000	1 1/2"	16	210	190	160	220	400	315	13.000		
150007025	1 1/2"	25	210	190	160	220	400	315	13.000		
150008000	2"	16	210	190	160	220	400	460	13.000		
150008025	2"	25	210	190	160	220	400	460	13.000		
1500040000	40	16	200	190	160	220	400	315	15.000	833115	
1500040025	40	25	200	190	160	220	400	315	15.000		
1500050000	50	16	230	190	160	220	400	506	16.200	833116	
1500050025	50	25	230	190	160	220	400	506	15.950		
1500065000	65	16	290	190	160	240	400	725	21.200	833117	
1500065025	65	25	290	190	160	240	400	725	20.700		
1500080000	80	16	310	190	180	250	400	1200	27.600	833118	
1500080025	80	25	310	190	180	250	400	1200	26.600		
1500100000	100	16	350	220	200	280	400	2150	35.400	833119	
1500100025	100	25	350	220	200	280	400	1770	34.600		
1500125000	125	16	400	230	210	360	500	2955	52.200	833141	
1500125025	125	25	400	230	210	360	500	2955	50.600		
1500150000	150	16	480	250	220	400	500	4960	76.200	833142	
1500150025	150	25	480	250	220	400	500	4960	76.000		
1500200000	200	10	600	260	250	450	500	7640	113.650		
1500200016	200	16	600	260	250	450	500	7640	113.650	833143	
1500200025	200	25	600	260	250	450	500	7640	113.650	833163	
1500250000	250	10/16	730	320	270	520	600	11600	165.000		
1500300000	300	10/16	850	420	280	510	600	24600	390.000		