

Pressure relief and pressure retention valve DAV

1400

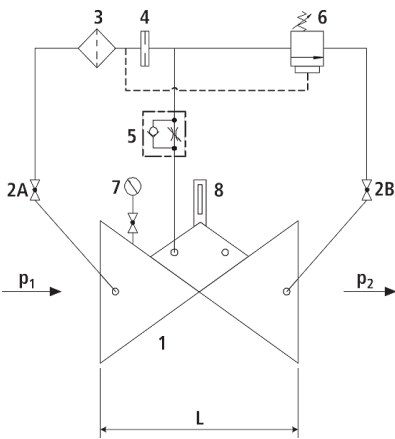
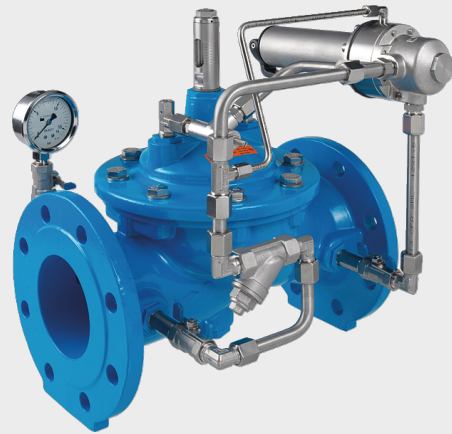
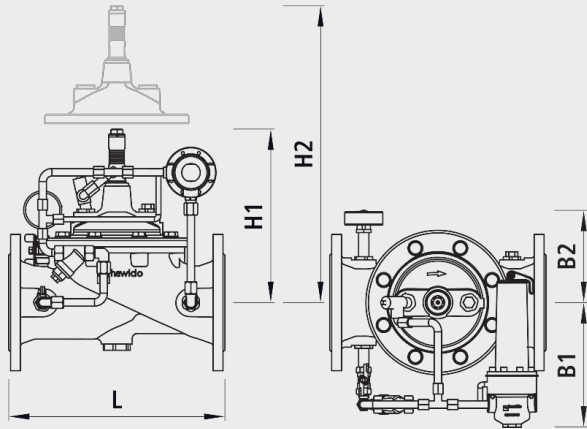

Components

- 1: Main valve
- 2: Ball valve (A, B)
- 3: Filter
- 4: Orifice
- 5: Throttle check valve
- 6: Control valve
- 7: Pressure gauge with ball valve
- 8: Optical position indicator (optional: Electrical position indicator, opening limiter)

Physical characteristics

- The main valve is a hydraulically operating diaphragm valve. The work energy is the inherent medium.
- Most valve types operate purely hydraulically without any foreign energy.

Application

- To use in drinking water systems (other media after consultation)
- Sustaining the network pressure in a supply
- Protecting the network by releasing excess pressure

Mode of operation

- The pressure relief valve maintains constant the pre-set inlet pressure (p_1). Any excess system pressure is relieved by fast opening of the valve. The closing procedure is slow in order to avoid shock pressure loads. Variable flow rates have no effect on the maintained pressure which is regulated by the control valve. The overpressure or maintained pressure can be set within the range of 2 bar to 16 bar (standard design).

Product information

- To calculate the dimensions of the valve please refer to the following information:
- Maximum and minimum inlet pressure (static and dynamic pressure ratios)
- Required sustained pressure or discharge pressure
- Maximum and minimum flow rates
- Available line diameters and lengths
- Construction of the valve (straight or angle design)
- For the calculation basis, information on the loss of pressure and the characteristic values of the valve, please refer to the end of Chapter E.

Design

- Design according to DIN EN 1074
- Construction length acc. to DIN EN 558
- Flange mass according to DIN 1092-2, to PN 25 DN 300
- Pressure levels: PN 10 or PN 16 to DN 300, PN 25 to DN 200, higher pressures on request.
- Nominal widths DN 50, DN 80, DN 100 and DN 150 available in angular design
- Nominal widths 1 1/2" and 2" with threaded connection (female thread)
- Medium temperature up to 40°C

Installation and assembly

















- Shut-off valves should be fitted on both sides of the valve and a dirt trap should be installed on the inlet side of the valve. If the valve outlet flows to the outside or into a shaft, the outlet slider can be omitted. Depending on the installation situation, a mounting/dismounting adapter should be provided.

Vantages

- Maintenance-free, non-rusting valve seat
- Pressed-in seat
- EWS-coating according to RAL GSK

Caution

- Dimension H1 with electric position indicator and opening limiter is 110 mm higher up to DN 100 and 130 mm higher at DN 125 to DN 300.

	DN	PN (bar)	L (mm)	B1 (mm)	B2 (mm)	H1 (mm)	H2 (mm)	KVS l/min.	weight (kg)	NPK No. 411	BIM / CAD
140007000	1 1/2"	16	210	190	160	220	400	315	11.900		
140008000	2"	16	210	190	160	220	400	315	13.750		
140008025	2"	25	210	190	160	220	400	460	13.750		
140040000	40	16	200	190	160	220	400	315	13.900	833215	
140040025	40	25	200	190	160	220	400	315	13.900		
140050000	50	16	230	190	160	220	400	506	16.250	833216	
140050025	50	25	230	190	160	220	400	506	16.250		
140065000	65	16	290	190	160	240	400	725	21.300	833217	
140065025	65	25	290	190	160	240	400	725	21.350		
140080000	80	16	310	190	180	250	400	1200	28.000	833218	
140080025	80	25	310	190	180	250	400	1200	27.400		
1400100000	100	16	350	220	200	280	400	2150	35.800	833219	
1400100025	100	25	350	220	200	280	400	1770	35.400		
1400125000	125	16	400	230	210	360	500	2955	51.500	833241	
1400125025	125	25	400	230	210	360	500	2955	51.500		
1400150000	150	16	480	250	220	400	500	4960	76.000	833242	
1400150025	150	25	480	250	220	400	500	4960	76.000		
1400200000	200	10	600	260	250	450	500	7640	114.600		
1400200016	200	16	600	260	250	450	500	7640	114.600	833243	
1400250000	250	10/16	730	320	270	520	600	11600	178.000		
1400300000	300	10/16	850	420	280	510	600	24600	358.000		