

Absperklappe mit Getriebe, Typ AW, PN 16

9941

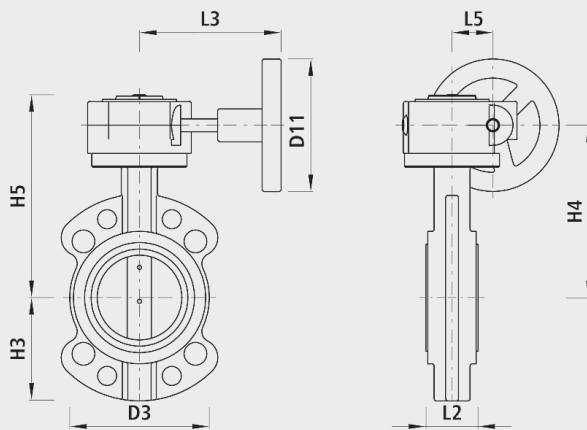

Anwendung

- Für Wasser bis max. 40 °C
- Einteiliges Gehäuse für den Einbau an die Flanschen nach DIN 2501, PN 10 oder PN 16.

Eigenschaften















- Die Klappenscheibe ist zentrisch gelagert und strömungsgünstig ausgebildet sowie in beide Durchflussrichtungen dicht schliessend.
- Flanschen-Anschlussmasse
 - nach DIN EN 1092-2
 - DN 40 bis DN 150: PN 10 / 16
 - DN 200 bis DN 400: PN 10 oder PN 16, bei Bestellung angeben
 - DN 65: 4-Loch-Flansch

Werkstoff

- Gehäuse: EN-JS 1030 (GGG 40)
- Scheibe: INOX 1.4408
- Welle: INOX 1.4005, mit Scheibenfeder
- Sitz: EPDM
- EWS-Beschichtung nach GSK, RAL-GZ 662, innen und aussen nach DIN 30677

Einbau und Montage

- Einklemmen zwischen zwei Flanschen
- Keine zusätzlichen Dichtungen verwenden.
- Direkte Verbindung mit Bördelflansch funktioniert nicht

	DN	PN (bar)	L2 (mm)	L3 (mm)	L5	D3 (mm)	D11	H3 (mm)	H4 (mm)	H5 (mm)	Gewicht (kg)	BIM / CAD
9941040000	40	16	36	128	39	110	125	61	156	181	3.600	
9941050000	50	16	46	128	39	118	125	78	150	175	4.700	
9941065000	65	16	49	128	39	137	125	90	160	185	5.200	
9941080000	80	16	49	128	39	148	125	98	167	192	5.700	
9941100000	100	16	56	137	39	159	125	115	186	219	6.800	
9941125000	125	16	59	137	39	189	125	122	200	233	8.800	
9941150000	150	16	59	153	52	211	200	148	216	249	11.000	
9941200000	200	10	65	153	52	269	200	180	248	281	17.600	
9941201000	200	16	65	153	52	269	200	180	248	281	17.600	
9941250000	250	10	73	192	52	324	200	210	284	326	23.600	
9941251000	250	16	73	192	52	324	200	210	284	326	23.600	
9941300000	300	10	81	218	67	375	250	250	320	362	38.600	
9941301000	300	16	81	218	67	375	250	250	320	362	38.600	
9941350000	350	10	81	289	67	440	300	268	413	465	55.000	
9941351000	350	16	81	289	67	440	300	268	413	465	55.000	
9941400000	400	10	107	309	89,5	494	400	315	445	497	72.000	